

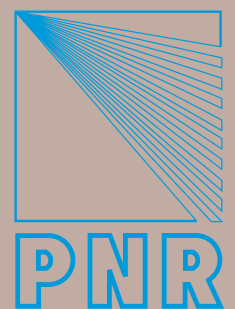

CTG SP10 BR

SPRAY DRY NOZZLES



INTRODUCTION

INDEX

Spraydry processes	_____	Page 1
Pressure nozzles	_____	2
Air assisted atomizers	_____	7
Additional information	_____	11

TECHNICAL PUBLICATIONS

PNR manufactures a complete range of spray nozzles for industrial application, and several products and systems based on spray technology.

Our complete product range is described by the following catalogues:

PRODUCT RANGE	CTG TV 10 BR
GENERAL PURPOSE SPRAY NOZZLES	CTG UG 14 BR
AIR ASSISTED ATOMIZERS	CTG AZ 15 BR
COMPLEMENTARY PRODUCTS AND ASSEMBLY FITTINGS	CTG AC 15 BR
INDUSTRIAL TANK WASHING SYSTEMS	CTG LS 15 BR
EVAPORATIVE COOLING LANCES	CTG LN 15 BR
SPRAYDRY NOZZLES	CTG SP 10 BR
STEELWORK NOZZLES	CTG SW 10 BR

Our technical publications are continuously updated, and mailed to Customers whose name and address are registered into our Catalogue Mailing List.

We shall gladly register your name, if you mail to the nearest PNR office the form on page 9, duly filled with the required information.

NOTES

Our products are continuously reconsidered and modified to keep up with the latest state of technology. We regret not to be able to give our Customers previous advice about these modifications: for this reason the data and product specifications given in this Catalogue are to be understood as indications, and do not engage our Company. In case your application should imperatively, require that one or more characteristics of one of our products is strictly maintained, we ask you to obtain a written confirmation about your requirements before sending your order.

All information contained into this Catalogue, including product data, product codes, diagrams and photographs are the exclusive property of Flowtech Srl. It is formally forbidden to reproduce any part of this Catalogue without having obtained written permission of Flowtech Srl.

Dimensions in this Catalogue are given in mm.

All threads are manufactured according to the ISO 259 standards (European norms BS 2779 - DIN 259 - UNI 338).

Explanations about the abbreviations used in the Catalogue are given at page 13.

All trademarks are the property of their respective owners.

EVAPORATIVE COOLING**GENERALITIES**

A spraydry process performs the action of separating water or another liquid from a solution, an emulsion or a suspension, for the purpose of obtaining the solid part of the feed fluid under the form of powder.

This is obtained pumping the liquid feed product into a tower, where the same is atomized into drops and put in contact with a stream of hot air. By heating through thermal convection, the liquid part of each drop evaporates, leaving the solid residue of the drop falling to the bottom of the tower as a powder grain.

Spraydry is a widely applied process in modern industry, and it is used to obtain either final or intermediate products under the form of powder in industries like food, chemical, pharmaceutical. There are three types of spray techniques being used in a spraydry system, that is:

- Air assisted nozzles
- Hydraulic pressure nozzles
- Atomization discs

The above techniques can give about the same drop size spectrum when atomizing liquids, and the choice among one of the three depends upon several factors in connection with the type of product to be handled.

The greatest importance must be attached to the drop size spectrum obtained by liquid atomization, since the dry-tower height depends directly upon the evaporation length of the drop. Producing a small size, narrow range droplet spectrum allows for smaller, more efficient towers.

SPRAY DRYERS AND ATOMIZERS

Discussing spraydryers it is not the purpose of this catalogue, hence we shall only deal with the basic factors influencing the efficiency of a dryer, including the functions of the atomizer.

In any dryer good mixing and efficient liquid-gas contact are of basic importance to assure rapid drying. The height of the dryer system is largely determined by the time required to dry the largest particle produced by the atomizer, while other important parameters are represented by the inlet-air temperature and the properties of the product being processed.

Spray drying has several advantages, the main one being the ability to handle heat-sensitive products such as food and pharmaceuticals. This is due to the fact that the drying process of a drop happens by losing water on the external layers, and this keeps the inside material in the drop cool or at least protected against excessive heat.

Disadvantages must be considered too, the two main disadvantages being the following:

- difficult to obtain high density products in all cases
- product recovery and dust collection require additional equipment and may increase global operation cost.

ATOMIZERS

The atomizer must assure some vital properties to allow for the spraydry process to be correctly performed:

- dispersing the incoming liquid into well distributed, minute droplets thoroughly mixed into hot air
- assure droplets size compatible with the desired characteristics of the final product
- assure a narrow droplet spectrum, since large droplets are difficult to evaporate, while small ones originate fine powder grains which are difficult to recover and handle.
- assure exact tolerances for capacity, since flow rate must be compatible with the other process parameters like air flow rate, air temperature and system capacity.
- assure a satisfactory erosion resistance, against abrasive solids passing through at high velocities.

PRESSURE NOZZLES

CENTRIFUGAL PRESSURE NOZZLES

The most widespread pressure atomizer, where the energy for atomization is supplied exclusively by the feed liquid pressure. In this type nozzle the liquid enters the whirl chamber through a slot in the side of the chamber itself, follows a tangential path around the inner chamber profile, and is then fed to the outlet orifice at high speed. Nozzle orifice, whirl chamber and nozzle top plate are made out of tungsten carbide or other wear resistant materials, to avoid rapid wear and consequent performance degradation. Bodies are manufactured from high quality Aisi 316 stainless steel.

These nozzles are well suited for atomizing high viscosity liquids with viscosities values up to several hundred centipoises. They are successfully used in counter-current spraydryers, and in systems using multiple nozzle lances. Capacities range up to several thousands of kgph for a single nozzle.



NOZZLES COMPONENTS

NOZZLE DESIGN

Tangential pressure atomizers are composed of several parts assembled into a stainless steel body, as shown from the drawings in this page.

The inside parts, made out of different wear resistant materials, determine the nozzle operational specification, and are described on next page.

The stainless steel body, insert and adapter are common to all nozzle types, as well as the orifice seal and the adapter seal. These parts can be ordered separately as spare parts, and their identification codes are given below in this page.

COMPONENTS

Assures assembly of nozzle onto the feed line, and is normally available with female BSPP thread, in the four different thread sizes listed in the table below.

Material Aisi 316L Stainless steel

Code nozzle adapter	Thread size BSPP
XRP B010 B31	1/4"
XRP B011 B31	3/8"
XRP B012 B31	1/2"
XRP B013 B31	3/4"

Code adapter seal	Material
XRP C011 E1	PTFE
XRP C011 T5	Copper

The nozzle holder assures that all the inside core components are properly assembled, and holds them into the correct operation position.

Code nozzle holder	Material
XRP F010 B3	

The top plate resists wear in the top part of the whirl chamber. It is available with round or square shape, with the codes shown in the beside table.

Material Tungsten carbide

Code top plate	Design
XRP G010 F1	Round
XRP G011 F1	Square

We offer a variety of whirl chambers, listed in the table shown next page.

**Material Aisi 420 stainless steel (hardened)
Tungsten carbide**

We offer a variety of orifice plates, listed in the table shown next page.

Material Tungsten carbide

Code orifice seal	Material
XRP C010 E1	PTFE
XRP C010 T5	Copper

Code nozzle body	Material
XRP A010 B3	Aisi 316 L

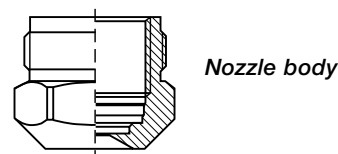
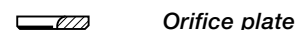
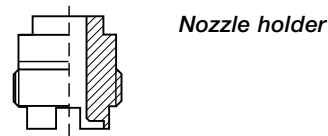
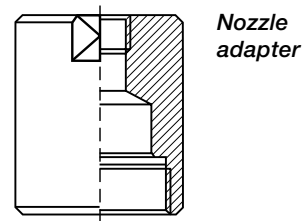
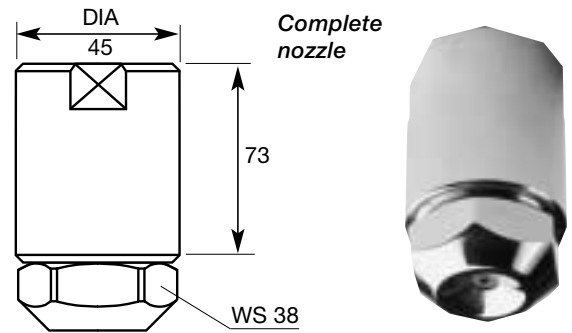

PRESSURE NOZZLES

NOZZLES COMPONENTS

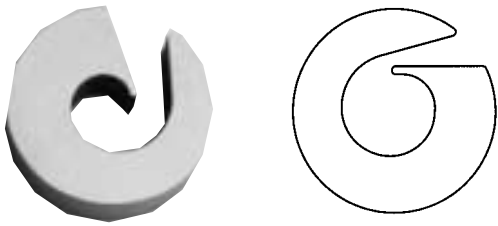

Whirl Chamber

WHIRL CHAMBER

The whirl chamber is the nozzle part where the liquid to be atomized, fed under pressure, is given a rotational speed which allows the centrifugal forces to generate the spray cone at the exit of the nozzle orifice. Because of the high values of feed pressure, the fluid is moving at high velocity inside the chamber, which originates a strong erosion with subsequent wear over the chamber inside surface. Two styles of whirl chambers are available, that is standard and with integrated top plate, which are identified by the codes in the table beside.

Materials C2 Aisi 420 stainless steel, hardened
F1 Tungsten carbide

Style	Standard	Integrated Top Plate
A	XRP E010 F1	XRP E030 F1
B	XRP E011 F1	XRP E031 F1
C	XRP E012 F1	XRP E032 F1
D	XRP E013 F1	XRP E033 F1
E	XRP E014 F1	XRP E034 F1
F	XRP E015 F1	XRP E035 F1

Style	Standard	Integrated Top Plate
G	XRP E016 F1	XRP E036 F1
H	XRP E017 F1	XRP E037 F1
I	XRP E018 F1	XRP E038 F1
J	XRP E019 F1	XRP E039 F1
K	XRP E020 F1	XRP E040 F1

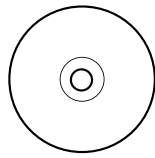
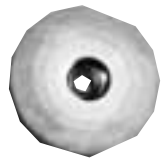

Nozzle Orifice

NOZZLE ORIFICE

The nozzle orifice receives the liquid sheet at high velocity, which is changed into minute droplets in the shape of a hollow cone spray. Here again the high liquid velocity originates wear from erosion, which causes the nozzle performance to decay with time. All orifices are carefully polished in the inside profile, to assure maximum exit velocity and finest droplet size. The orifice diameter needs to be kept under control to ensure acceptable nozzle performance.

Material F1 Tungsten carbide

Code	D
XRP D033 F1	0,84
XRP D034 F1	0,86
XRP D036 F1	0,91
XRP D040 F1	1,02
XRP D041 F1	1,04
XRP D044 F1	1,12
XRP D048 F1	1,22
XRP D054 F1	1,37
XRP D056 F1	1,42
XRP D059 F1	1,50
XRP D060 F1	1,52

Code	D
XRP D062 F1	1,57
XRP D066 F1	1,68
XRP D069 F1	1,75
XRP D071 F1	1,80
XRP D075 F1	1,91
XRP D076 F1	1,93
XRP D077 F1	1,96
XRP D083 F1	2,11
XRP D089 F1	2,26
XRP D090 F1	2,29
XRP D092 F1	2,34

Code	D
XRP D094 F1	2,39
XRP D099 F1	2,51
XRP D100 F1	2,54
XRP D102 F1	2,59
XRP D107 F1	2,72
XRP D108 F1	2,74
XRP D114 F1	2,90
XRP D115 F1	2,92
XRP D125 F1	3,18
XRP D127 F1	3,23
XRP D128 F1	3,25

Code	D
XRP D133 F1	3,38
XRP D135 F1	3,43
XRP D141 F1	3,58
XRP D144 F1	3,66
XRP D151 F1	3,84
XRP D155 F1	3,94
XRP D156 F1	3,96
XRP D160 F1	4,06

COMPLETE NOZZLE CODE

The code for a complete pressure nozzle are given in the following. Replace X, Y and Z with the following

RPQ X 023 B3 YZ

X / Whirl Chamber Style	
A	Standard whirl chamber
B	Integrated top plate

Y / Adapter thread			
A	1/4"	C	1/2"
B	3/8"	D	3/4"

Z / Thread type	
B	BSPT
N	NPT

PRESSURE NOZZLES

PERFORMANCES TABLES

	Nozzle Code	Capacity at different pressures values (lph) (bar)								Fwh	Orifice & Chamber
		50	75	100	150	200	300	400	500		
60°	RPQ X013 B3Y	98.3	119	135	165	189	228	265	293	0301	XRP D036 F1 XRP E013 F1
	RPQ X020 B3Y	145	178	205	249	285	347	400	436	0602	XRP D041 F1 XRP E014 F1
	RPQ X023 B3Y	164	199	229	279	321	390	451	508	0702	XRP D044 F1 XRP E014 F1
	RPQ X025 B3Y	180	216	250	303	350	427	496	552	0802	XRP D048 F1 XRP E014 F1
	RPQ X036 B3Y	260	316	366	440	515	630	725	819	1102	XRP D056 F1 XRP E015 F1
	RPQ X041 B3Y	293	356	409	505	585	711	812	930	1202	XRP D060 F1 XRP E015 F1
	RPQ X068 B3Y	488	595	685	838	970	1172	1385	1555	1702	XRP D075 F1 XRP E016 F1
	RPQ X110 B3Y	780	950	1099	1340	1545	1915	2220	2490	2002	XRP D090 F1 XRP E017 F1
	RPQ X124 B3Y	880	1090	1240	1522	1774	2186	2528	2835	2102	XRP D099 F1 XRP E017 F1
	RPQ X183 B3Y	1290	1580	1830	2240	2585	3196	3711	4170	2402	XRP D115 F1 XRP E016 F1
	RPQ X206 B3Y	1460	1790	2064	2525	2925	3615	4210	4730	2502	XRP D128 F1 XRP E018 F1
	RPQ X274 B3Y	1950	2370	2748	3330	3870	4780	5488	5895	2801	XRP D135 F1 XRP E019 F1
	RPQ X296 B3Y	2110	2550	2961	3595	4178	5110	5890	6500	2901	XRP D151 F1 XRP E019 F1
RPQ X456 B3Y	3210	3945	4560	5590	6470	7920	9145	10220	3201	XRP D160 F1 XRP E020 F1	
75°	RPT X011 B3Y	82	99	112	135	156	188	220	245	0202	XRP D040 F1 XRP E011 F1
	RPT X018 B3Y	128	155	180	222	256	315	365	406	0503	XRP D054 F1 XRP E012 F1
	RPT X020 B3Y	145	178	203	250	289	348	410	440	0603	XRP D054 F1 XRP E012 F1
	RPT X032 B3Y	225	279	325	398	455	565	654	730	1004	XRP D069 F1 XRP E013 F1
	RPT X051 B3Y	360	440	510	625	730	908	1020	1145	1501	XRP D083 F1 XRP E014 F1
	RPT X055 B3Y	390	470	545	660	771	950	1092	1221	1604	XRP D089 F1 XRP E014 F1
	RPT X083 B3Y	580	705	830	1018	1180	1460	1720	1910	1803	XRP D102 F1 XRP E015 F1
	RPT X095 B3Y	670	830	955	1190	1375	1712	1980	2195	1904	XRP D114 F1 XRP E015 F1
	RPT X137 B3Y	955	1180	1370	1692	1964	2415	2826	3149	2204	XRP D128 F1 XRP E016 F1
	RPT X161 B3Y	1120	1360	1610	1975	2282	2884	3290	3698	2304	XRP D144 F1 XRP E016 F1
	RPT X229 B3Y	1610	1960	2290	2810	3260	4030	4675	5220	2603	XRP D156 F1 XRP E017 F1

PRESSURE NOZZLES

PERFORMANCES TABLES

	Nozzle Code	Capacity at different pressures values (lph) (bar)								Fwh	Orifice & Chamber
		50	75	100	150	200	300	400	500		
80°	RPU X009 B3Y	64	78	90	108	125	155	179	196	0102	XRP D033 F1 XRP E010 F1
	RPU X016 B3Y	110	133	158	195	228	276	318	353	0403	XRP D054 F1 XRP E011 F1
	RPU X023 B3Y	160	198	230	281	325	396	457	516	0704	XRP D060 F1 XRP E012 F1
	RPU X025 B3Y	175	213	249	306	355	432	503	560	0804	XRP D066 F1 XRP E012 F1
	RPU X028 B3Y	190	235	278	336	388	479	551	616	0904	XRP D071 F1 XRP E012 F1
	RPU X036 B3Y	252	310	358	438	515	632	725	818	1104	XRP D076 F1 XRP E013 F1
	RPU X041 B3Y	286	352	408	506	589	716	819	936	1204	XRP D083 F1 XRP E013 F1
	RPU X045 B3Y	320	390	450	562	650	803	927	1038	1303	XRP D092 F1 XRP E013 F1
	RPU X068 B3Y	478	587	677	832	970	1174	1383	1554	1704	XRP D108 F1 XRP E014 F1
	RPU X110 V3Y	770	941	1094	1340	1548	1916	2223	2492	2004	XRP D127 F1 XRP E015 F1
	RPU X124 B3Y	872	1084	1238	1522	1776	2188	2529	2838	2104	XRP D141 F1 XRP E015 F1
85°	RPV X011 B3Y	80	97	110	134	159	193	220	247	0203	XRP D048 F1 XRP E010 F1
	RPV X013 B3Y	98	119	136	168	191	230	268	298	0303	XRP D059 F1 XRP E010 F1
	RPV X018 B3Y	128	155	180	222	257	315	362	404	0504	XRP D062 F1 XRP E011 F1
	RPV X020 B3Y	145	178	204	250	288	348	409	441	0604	XRP D069 F1 XRP E011 F1
	RPV X032 B3Y	225	279	324	396	455	562	653	725	1005	XRP D083 F1 XRP E012 F1
	RPV X051 B3Y	360	440	510	625	730	908	1020	1145	1502	XRP D100 F1 XRP E013 F1
	RPV X055 B3Y	390	470	545	660	771	950	1092	1221	1605	XRP D108 F1 XRP E013 F1
	RPV X083 B3Y	580	705	830	1018	1180	1460	1720	1910	1804	XRP D125 F1 XRP E014 F1
	RPV X095 B3Y	670	832	956	1192	1378	1708	1974	2194	1905	XRP D141 F1 XRP E014 F1
	RPV X137 B3Y	959	1178	1368	1688	1958	2414	2804	3144	2205	XRP D155 F1 XRP E015 F1
90°	RPW X016 B3Y	110	135	158	197	228	278	316	354	0404	XRP D069 F1 XRP E010 F1
	RPW X023 B3Y	158	196	228	283	324	396	455	512	0705	XRP D077 F1 XRP E011 F1
	RPW X036 B3Y	250	310	357	442	516	634	728	818	1105	XRP D094 F1 XRP E012 F1
	RPW X041 B3Y	286	352	408	507	590	718	821	938	1205	XRP D107 F1 XRP E012 F1
	RPW X068 B3Y	486	590	675	824	961	1163	1368	1538	1705	XRP D133 F1 XRP E013 F1

AIR ASSISTED LANCES

In these nozzles an additional fluid, compressed air, supplies most of the energy required for dispersing the liquid flow fed to the nozzle into minute droplets. The liquid, which is admitted to the whirl chamber under a relatively low pressure, is broken into small droplets by means of a three stage process, that is:

- the liquid flow is first led to impact against a solid surface, thus being broken into drops
- the resulting drops are then applied noticeable shear forces by the high speed air flow
- the drops impinge onto the deflector and are finally entrained into the air flow existing the atomizer.

In those cases where it is possible to accept the higher energy cost required from the supply of compressed air, very fine droplets can be obtained. Air assisted atomizers are specially effective when viscous liquids need to be atomized.



AIR ASSISTED ATOMIZERS

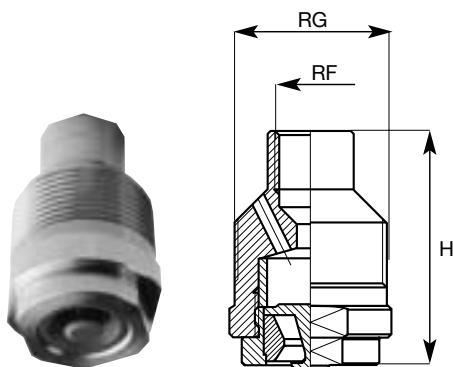

NOZZLE DIMENSIONS

Air assisted atomizers in the MG style are available in three different sizes, whose dimensions are given in the table below. MG atomizers are normally operated while assembled onto a lance, which is designed according to the requirements of the single application, and can be quoted on request.

Nozzle sizes			
Size	RG	RF	H
1	1/2"	1/8"	38
2	3/4"	1/4"	54
3	1"	1/4"	54
4	1 + 1/4"	1/2"	60

Nozzle materials	
Body	Pintle deflector
Aisi 316 stainless steel	Aisi 316 stainless steel
Hastelloy C 276	Hastelloy C 276
	Tungsten carbide (size 4 only)

COMPLETE NOZZLE CODE

A complete nozzle can be specified by the following code. Please note that two different material code are to be specified, the nozzle body (here B3 = 316) and the pintle material as later on specified.

MG X 2560 B3 YZ

X / Spray Angle		Y / Pintle Material		Z / Thread Type	
N	50 degrees	B	Aisi 316	B	BSPT
S	75	F	Tungsten carbide	N	NPT
V	100	H	Hastelloy C 276		

NOZZLE COMPONENTS

ATOMIZER DESIGN

Air assisted atomizers are normally operated with fluids supplied at low or very low pressure values, and therefore negligible wear is to be expected. However, when the liquid to be atomized contains solid particles, erosion and subsequent wear can cause nozzle performances to decay in very short times. There are therefore two different designs for air assisted atomizers, as shown below. The drawings beside show the atomizer composition for the two different designs. Identification codes for the single components can be obtained on our Data Sheets series 9YR A for stainless steel atomizers and 9YR B for atomizer with Tungsten Carbide inserts..

STANDARD DESIGN

The atomizer is composed by three parts machined out of high quality alloys. All the four sizes are available in this design.

Materials	
B31	Aisi 316L stainless steel
L8	Hastelloy C 276 (on request)

WEAR RESISTANT DESIGN

Here the inside parts subject to erosion are made out of hard metal and can be replaced when worn out. Only size no. 4 is available with this design.

Materials	
B31	Aisi 316L stainless steel
F1	Tungsten carbide (replaceable parts only)

Atomizer body

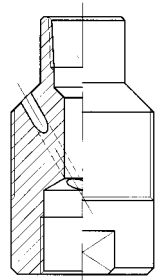

Impingement member



Atomizer orifice

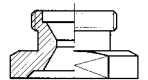

Atomizer body

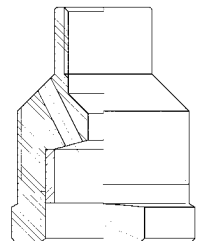

Impingement member

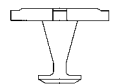

Orifice holder



AIR ASSISTED ATOMIZERS

L = Water capacity lpm
A = Air Capacity ncmh

AIR PRESSURE (bar)

Code	1,5			2,0			2,5			3,0			
	AP	L	A	AP	L	A	AP	L	A	AP	L	A	
50°	MGN 2560	1,4	28,0	47,0	1,4	37,0	36,0	1,4	45,0	29,0	1,4	53,0	22,0
		2,8	18,0	114	2,8	23,0	107	2,8	30,0	94,0	2,8	37,0	84,0
		4,2	-	-	4,2	18,0	168	4,2	22,0	160	4,2	28,0	149
	MGN 2370	1,4	17,0	28,0	1,4	22,0	23,0	1,4	26,0	17,0	1,4	30,0	14,0
		2,8	9,50	69,0	2,8	14,0	60,0	2,8	19,0	54,0	2,8	21,0	46,0
		4,2	-	-	4,2	7,80	93,0	4,2	13,0	87,0	4,2	16,0	90,0
	MGN 2150	1,4	5,80	11,0	1,4	8,00	14,5	1,4	10,5	2,00	1,4	12,5	1,50
		2,8	1,45	35,0	2,8	3,20	31,0	2,8	5,10	24,0	2,8	7,50	19,8
		4,2	-	-	4,2	1,05	54,0	4,2	1,90	41,0	4,2	3,80	43,0
	MGN 1950	1,4	-	-	1,4	-	-	1,4	-	-	1,4	-	-
		2,8	1,20	19,0	2,8	2,70	11,5	2,8	1,80	9,00	2,8	-	-
		3,4	-	-	3,4	1,80	24,5	3,4	3,60	19,0	3,4	5,70	14,0
	MGN 1380	2,1	0,70	7,80	2,1	2,21	3,00	2,1	-	-	2,1	-	-
		2,8	-	-	2,8	0,65	11,0	2,8	0,80	7,80	2,8	3,90	1,90
		3,4	-	-	3,4	-	-	3,4	1,00	12,5	3,4	0,90	9,00
75°	MGS 2560	1,4	28,0	47,0	1,4	37,0	36,0	1,4	45,0	29,0	1,4	53,0	22,0
		2,8	18,0	114	2,8	23,0	107	2,8	30,0	94,0	2,8	37,0	84,0
		4,2	-	-	4,2	18,0	168	4,2	22,0	160	4,2	28,0	149
	MGS 2370	1,4	17,0	28,0	1,4	22,0	23,0	1,4	26,0	17,0	1,4	30,0	14,0
		2,8	9,50	69,0	2,8	14,0	60,0	2,8	19,0	54,0	2,8	21,0	46,0
		4,2	-	-	4,2	7,80	93,0	4,2	13,0	87,0	4,2	16,0	90,0
	MGS 2150	1,4	5,80	11,0	1,4	8,00	14,5	1,4	10,5	2,00	1,4	12,5	1,50
		2,8	1,45	35,0	2,8	3,20	31,0	2,8	5,10	24,0	2,8	7,50	19,8
		4,2	-	-	4,2	1,05	54,0	4,2	1,90	41,0	4,2	3,80	43,0
	MGS 1950	1,4	-	-	1,4	-	-	1,4	-	-	1,4	-	-
		2,8	1,20	19,0	2,8	2,70	11,5	2,8	1,80	9,00	2,8	-	-
		3,4	-	-	3,4	1,80	24,5	3,4	3,60	19,0	3,4	5,70	14,0
	MGS 1380	2,1	0,70	7,80	2,1	2,21	3,00	2,1	-	-	2,1	-	-
		2,8	-	-	2,8	0,65	11,0	2,8	0,80	7,80	2,8	3,90	1,90
		3,4	-	-	3,4	-	-	3,4	1,00	12,5	3,4	0,90	9,00
100°	MGV 2560	1,4	28,0	47,0	1,4	37,0	36,0	1,4	45,0	29,0	1,4	53,0	22,0
		2,8	18,0	114	2,8	23,0	107	2,8	30,0	94,0	2,8	37,0	84,0
		4,2	-	-	4,2	18,0	168	4,2	22,0	160	4,2	28,0	149
	MGV 2370	1,4	17,0	28,0	1,4	22,0	23,0	1,4	26,0	17,0	1,4	30,0	14,0
		2,8	9,50	69,0	2,8	14,0	60,0	2,8	19,0	54,0	2,8	21,0	46,0
		4,2	-	-	4,2	7,80	93,0	4,2	13,0	87,0	4,2	16,0	90,0
	MGV 2150	1,4	5,8	11,0	1,4	8,00	14,5	1,4	10,5	2,00	1,4	12,5	1,50
		2,8	1,45	35,0	2,8	3,20	31,0	2,8	5,10	24,0	2,8	7,50	19,8
		4,2	-	-	4,2	1,05	54,0	4,2	1,90	41,0	4,2	3,80	43,0
	MGV 1950	1,4	-	-	1,4	-	-	1,4	-	-	1,4	-	-
		2,8	1,20	19,0	2,8	2,70	11,5	2,8	1,80	9,00	2,8	-	-
		3,4	-	-	3,4	1,80	24,5	3,4	3,60	19,0	3,4	5,70	14,0
	MGV 1380	2,1	0,70	7,80	2,1	2,21	3,00	2,1	-	-	2,1	-	-
		2,8	-	-	2,8	0,65	11,0	2,8	0,80	1,80	2,8	3,90	1,90
		3,4	-	-	3,4	-	-	3,4	1,00	12,5	3,4	0,90	9,00

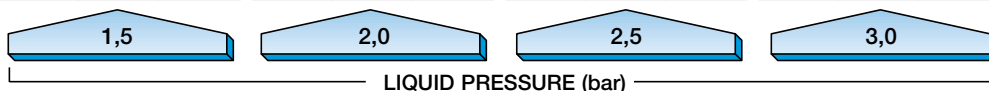

ADDITIONAL INFORMATION

INQUIRY DATA SHEET

It is not always easy to identify the most suitable nozzle for a given application just searching the Catalogue pages and the nozzle performance tables.

For this reason we make available Data Sheet 8RP A001 R1 where our Customers can list all the possible information about the liquid to be sprayed and the process parameters. When this information is available, our offices shall recommend the best nozzle for your individual process.

8RP-A001-R1

**Spraydry nozzle
Inquiry sheet**

Name	Date
Company	Phone
City, Zipcode	E-mail
Address	Fax
Liquid sprayed	Specific gravity
pH value	Viscosity
Percentage solids	Liquid temperature
Nozzle used today	Manufacturer
Nozzel flow rate	Nozzel spray angle
Number of nozzles	Nozzel size
Wear site	Inside material
Plant manufacturer	Current / Countercurrent
Inlet air temperature	Outlet air temperature
Operating pressure	Maximum available pressure
Tower diameter	Pump manufacturer

COMPLEMENTARY PRODUCTS

TANKWASHERS

In most of the spraydry plants it is necessary to maintain the inside of ducts and tanks in a condition of perfect cleanliness to avoid build-up of powder.

Pnr offers one of the most complete ranges in the world of high quality tankwashers, made out of food approved stainless steel and plastic material types.

You will find in our Tank Washing Catalogue CTG LS14 BR tankwashers entering pipes as small as 1" or capable to clean tanks up to 12 m in diameter.

In addition, with several thousands tankwashers sold every year, our engineers will put their remarkable experience at your service for a professional advice.



PINTLE NOZZLE

An additional product of interest for spraydry process engineers is our range of pintle nozzles, an ingenious cleaning in place device where the pintle head stays normally closed when not operating, thus avoiding the inlet of powder into the nozzle and the supply line.

When the nozzle is fed with washing liquid under pressure, the head pops up and produces a 360° spray to wash the surrounding area.

Please ask for our UAE series Data Sheets.



ORIFICE MEASURING GAUGE

Small amounts of wear can produce noticeable changes in the capacity of RP pressure nozzles.

In order to keep a strict control over this vital nozzle dimension, we make available to our Customers a precision, purpose-built instrument.

This instrument, with a range 0.5 to 5.0 mm covers the whole range of orifice discs for RP style nozzles and converts diameter measurements to a magnified linear scale readout.

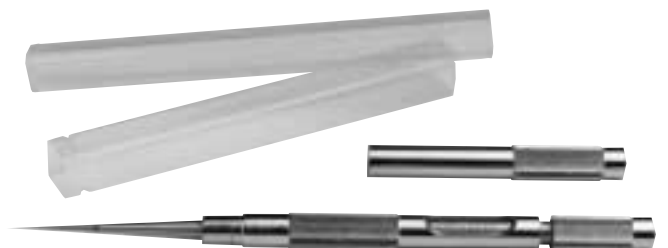

ADDITIONAL INFORMATION**ABBREVIATIONS**

A	Air capacity	ncm/h	H	Height	mm
AP	Air pressure	bar	L	Liquid capacity	Lpm
D	Conventional orifice dia	mm	NR	Number of orifices	-
DIA	Outside diameter	mm	RF	BSP Female thread	Inch
DN	Flange nominal dia	mm	RG	BSP Male thread	Inch

PRODUCT WARRANTY

Pnr products will be replaced or repaired, at the option of Pnr and free of charges, if found defective in manufacturing, labeling or packaging.

The above warranty conditions will apply if notice of defect is received by Pnr within 30 days from date of product installation or one year from date of shipment.

The cost of above said replacement or repair shall be the exclusive remedy for any breach of any warranty, and Pnr shall not be held liable for any damage due to personal injuries or commercial losses coming from product malfunction.

Our Company Procedure for warranty requires the following steps:

- 1 Contact our Quality Manager and obtain from Pnr a return authorization number
- 2 Return the products together with our form 3DA A04 duly filled
- 3 We shall issue a test report, send you a copy and return the product (replaced or repaired).

Our Company scope is obtaining full Customer satisfaction, and we are fully aware of the inconvenience which can be originated from a defective product.

Please be assured we shall do our best to make available a perfect product in the shortest possible time.

We also provide, for products which are not defective, a product return policy as follows.

PRODUCTS DELIVERED IN ERROR FROM PNR

- 1 Obtain from Pnr a return authorization number
- 2 Return the products together with our form duly filled
- 3 Pnr shall issue a Credit Note for full product and shipping costs.

PRODUCTS ORDERED INCORRECTLY TO PNR

- 1 Obtain from Pnr a return authorization number
- 2 Return the products, at your expense, together with our form duly filled
- 3 Products shall be in original conditions, inside the original packing
- 4 A re-stocking charge of 15% applies.
- 5 Pnr shall issue a credit note for 85% of the original product cost

NON CATALOG PRODUCTS

Can only be returned after a quotation from Pnr is obtained.

SENDING LIST

In order to receive automatically updates of our Catalogues, please photocopy the card below and mail it to any Pnr Office in a sealed envelope. Your details will be recorded into our permanent mailing list.

CTG SP10 BR

01	COMPANY		SPRAY NOZZLES	
02	NAME		AIR ASSISTED ATOMIZERS	
03	FUNCTION		EVAPORATIVE COOLING LANCES	
04	ADRESS		SPRAYDRY NOZZLES	
05	PHONE	FAX	TANK WASHING SYSTEMS	
06	WEB SITE	E MAIL	ACCESSORIES AND FITTINGS	



PNR UK LTD

16, Sugarbrook Rd - Aston Fields Ind. Estate
BROMSGROVE WORCS B60 3DW
Tel. (01527) 579066 - Fax (01527) 579067
www.pnr-nozzles.com - E-mail: spraynozzles@pnr.co.uk

CTG SP10 BR



Our products are distributed through:

PNR America
PNR Asia
PNR Benelux

PNR Brasil
PNR Czech Republic
PNR Deutschland
PNR France

PNR Italia
PNR Mexico
PNR U. Kingdom

We are moreover represented in:

Argentina
Australia
Austria
Canada
Chile
Denmark
Finland
Greece
India

Indonesia
Iran
Ireland
Japan
Slovenia
Korea
Nepal
Norway
N. Zealand

Pakistan
Poland
Portugal
Singapore
South Africa
Spain
Sweden
Taiwan
Venezuela